

**EXO-GT920**

**SCORPION**  
**EXO**

**TECHMANUAL**



# EXO-GT920

PERFORMANCE FEATURES

## 1 Ellip-Tec® Base Plate

ELLIP-TEC®

Scorpion's ratchet system uses an elliptical motion that creates 7.6mm of travel which pulls the shield securely against the eye port, ensuring a proper seal. The Ellip-Tec ratchet system allows for 100% tool-less shield changing in a matter of seconds.

## 2 SpeedView® Retractable Sun-Visor

EVERCLEAR  
SPEEDVIEW®  
SUNVISOR

Retractable internal sun visor changes positions with a simple slide of a switch.

## 3 Everclear® No Fog Face Shield

EVERCLEAR®  
NO-FOG FACESHIELD

Optically-clear shield with state-of-the-art fog-free technology, anti-scratch hardened coating and 100% UV protection. City-Mode tab allows the shield to be locked or left slightly open for a gentle flow of air to the shield and helmet interior.

## 4 KwikWick® II Removable/Washable Anti-Microbial Liner

KWIKWICK® II  
LINER

Scorpion's moisture-wicking lining material feels cool to the touch in warm weather and warm in cool weather while maintaining anti-microbial and hypo-allergenic properties.

## 5 KwikFit® Cheek Pads

KWIKFIT

Kwikfit™ cheek pads allow easy on and off of the most common styles of eye glasses.

## 6 Flip-up chin bar

A single button release allows the chin bar to be raised or lowered with either hand.

## 7 Aero-Tuned ventilation system

Intake ports across the front of the helmet force cool air into the helmet interior while exhaust vents maximize movement of hot air out of the helmet.

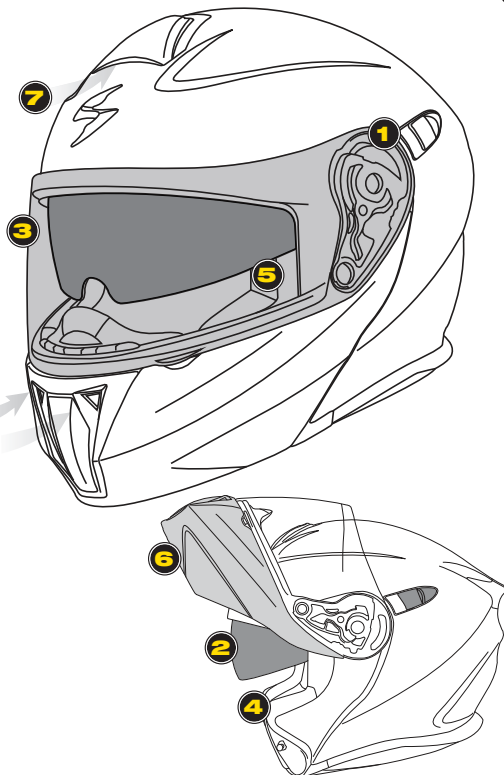

## Introduction



Congratulations for acquiring a premium ScorpionExo® helmet. This helmet embodies the latest, state-of-the-art design, engineering and technology available in the market today and is an excellent investment for your comfort and protection.

**Please remember that no helmet can protect you against all possible or foreseeable impacts even when built with the latest and best materials and technology.**

The following information will help you to enjoy and properly care for your helmet.

## Function



A helmet's main function is to protect your head from impact in case of an accident. To accomplish this, a helmet surrounds your head with a matrix of materials designed to absorb and cushion impact energy in some accidents. A helmet is also designed to provide you with comfort while riding at speed and in various weather conditions. Yet, there is a trade-off: A helmet decreases hearing sensitivity, peripheral vision and physical movement to a certain extent while providing protection and comfort.

## Fit



It is important for maximum safety that your ScorpionExo® helmet fit snugly and comfortably on your head with the retention strap (chinstrap) properly and snugly fastened. With the chinstrap firmly fastened, grab the back of the helmet with both hands and try to roll the helmet forward. If you can roll the helmet over the eyes, it is too loose and you should try another size of helmet.

## FaceShields



The faceshield on your ScorpionExo® helmet provides protection from weather, small flying objects and wind. Tinted shields are available to protect your eyes from excessive sunlight. The ScorpionExo® SpeedView® internal sunvisor system allows you to instantly tint the sunlight.

### **!WARNING!**

**NEVER USE A DARK OR TINTED FACESHIELD OR SPEEDVIEW VISOR IN DARK OR POOR VISIBILITY RIDING CONDITIONS.**

This is not only unsafe, but also illegal in most countries.

**NEVER WEAR A FACESHIELD THAT HAS BECOME SCRATCHED, OR RIDE WITH A FACESHIELD THAT IS FOGGED BY CONDENSATION. SCORPIONEXO® FACESHIELDS (CLEAR AND SMOKE ONLY) COME WITH A SCRATCH-RESISTANT COATING.**

## Ventilation Systems



Ventilation systems are designed and engineered to maximize your comfort in a wide range of temperatures. Familiarize yourself with the vents on your street helmet. Some vents have detents allowing partial opening and closing, thereby controlling intake and exhaust airflow. Your helmet ventilation systems should be kept clear of any obstructions including dirt, insects or other items which could interfere with proper flow of air. The ventilation systems play an important role, especially during physical exertion or hot-weather riding. Ventilation helps decrease the possibility of fogging on the faceshield.

## FRONT VIEW OF THE HELMET

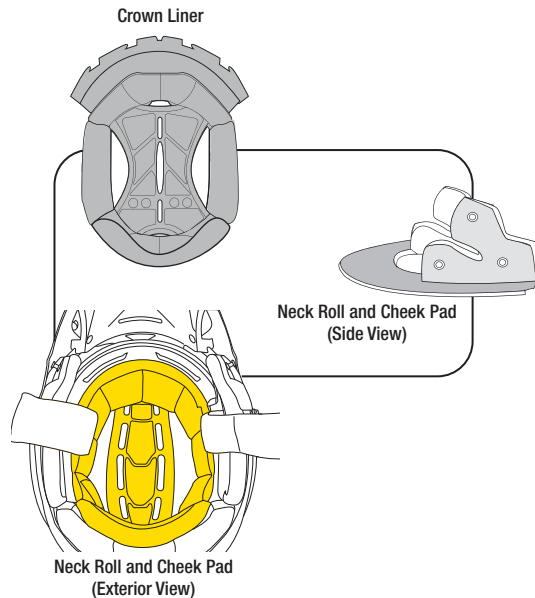
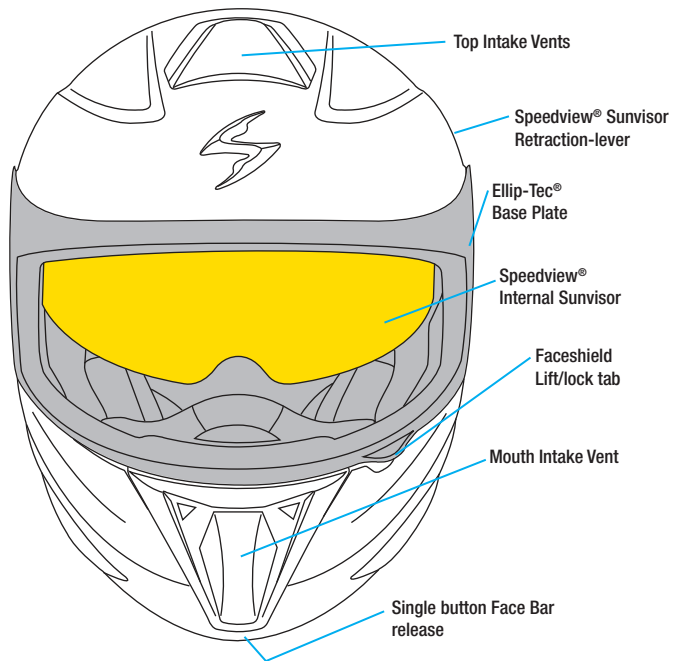

**!WARNING!** Always check to make sure the crown liner, neckroll and cheek pad are installed before using the helmet. A helmet without the crown liner and/or cheekpad may increase your risk of serious injury or death.

## USING THE RETRACTABLE SPEEDVIEW® SUNVISOR

NOTE: THE RETRACTABLE INTERNAL SUNVISOR CAN BE LOWERED AND RETRACTED, REGARDLESS OF WHETHER OR NOT THE FACESHIELD IS UP OR DOWN.

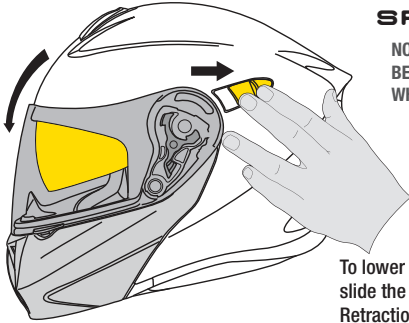

To lower the sunvisor, simply slide the SpeedView® Sunvisor Retraction-lever towards the back of the helmet.

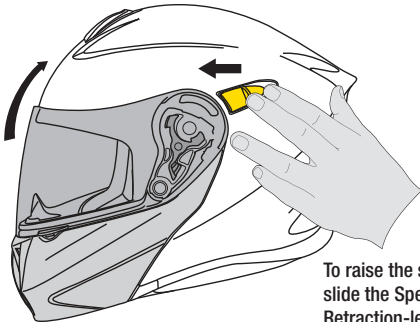

To raise the sunvisor, just slide the SpeedView® Sunvisor Retraction-lever towards the front of the helmet.

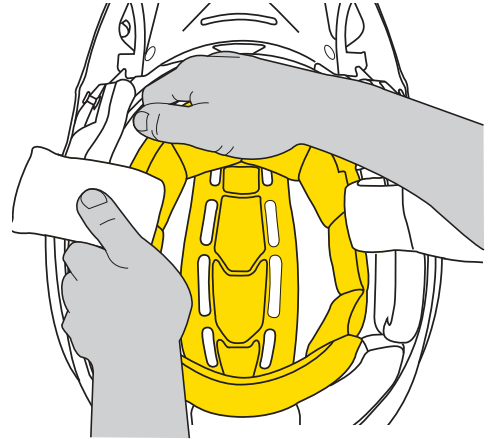

## REMOVING THE NECK ROLL AND ATTACHED CHEEKPADS

Gently pull cheek pads away from the interior wall of helmet to unsnap the three plastic clips on each side. Next, gently tug away the Neck Roll with attached cheek pads away from helmet.



**DO NOT ATTEMPT TO ADJUST WHILE RIDING**



## REMOVING THE CROWN LINER

After removing the cheek pads, reach into the helmet and pull out the Crown-liner shown below. The front part of the liner is snapped to the helmet liner frame. Gently detach it from the forehead channel and pull away from interior of helmet.

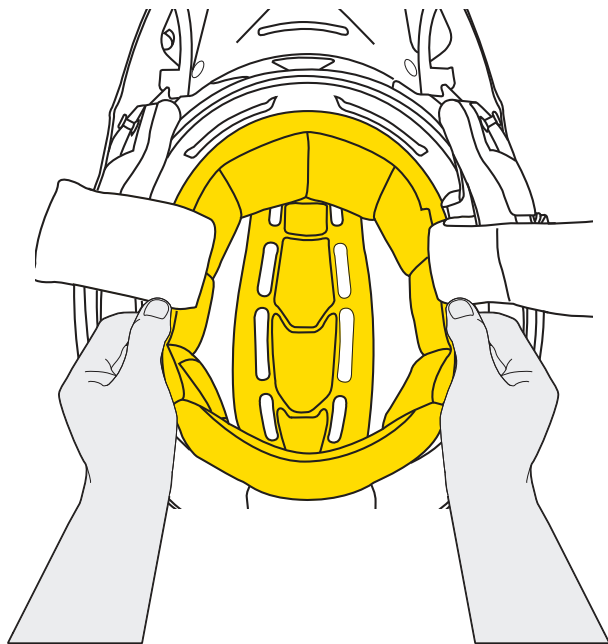

## REMOVAL OF SPEEDVIEW® SUNVISOR FOR CLEANING OR REPLACEMENT

**NOTE: FIRST, OPEN OUTER SHIELD TO THE HIGHEST POSITION. THEN LOWER THE SUNVISOR TO LOWEEST POSSIBLE POSITION. (See page 4)**

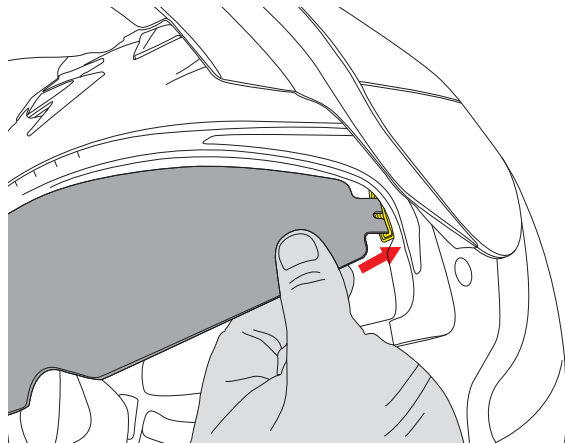
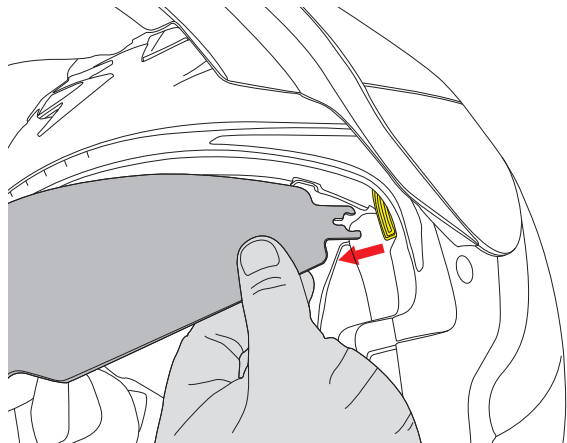

**Firmly hold the sunvisor with your hand and gently pull one side out away from the helmet to release. Repeat to release the opposite side.**

Reverse process for installation.

## OPERATION OF FLIP UP CHIN BAR

1

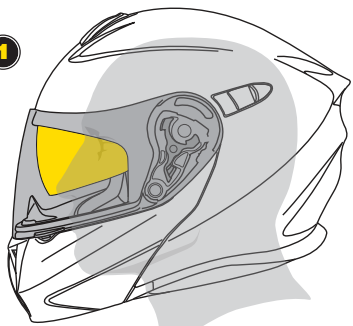

2

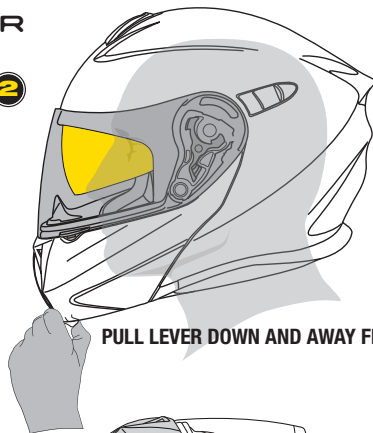

PULL LEVER DOWN AND AWAY FROM FACE

3

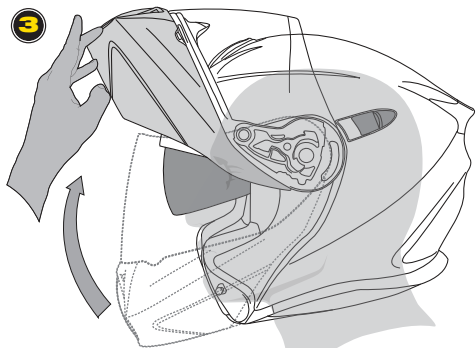

4

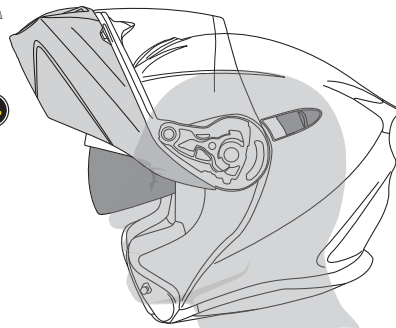

**!WARNING! BE SURE THAT CHIN BAR IS CLOSED SECURELY!  
DO NOT OPERATE MOTORCYCLE WITH CHIN BAR IN OPEN POSITION!**



**DO NOT ATTEMPT TO ADJUST WHILE RIDING**





## FACESHIELD REPLACEMENT

**NOTE: THE FACESHIELD CAN ONLY BE REMOVED OR INSTALLED WHEN IN THE FULLY OPENED POSITION!!!**

To remove your faceshield, place the helmet in front of you with the eye port facing away. Ratchet the faceshield up to the fully open position. Using both hands, push up the Y shape release latchet upward and the shield is able to release out of locking mechanism. Then, with both of your thumbs pushing squarely on the center of the Ellip-Tec™, gently pull or “peel” the faceshield away from the helmet.

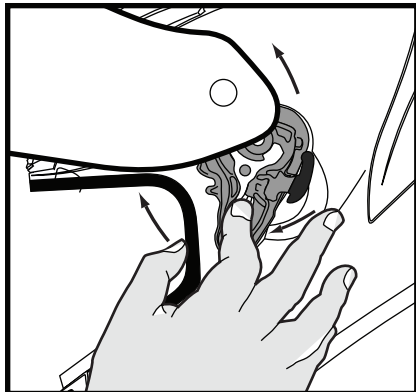

**IMPORTANT NOTE:**  
Be sure to latch up the “Y” release latchet while removing the faceshield!

## SECURING AND WEARING YOUR HELMET

Do not simply pull your helmet down onto your head like a hat. Your ScorpionExo® helmet should be worn as follows: Using both hands grab the helmet's bottom rim while holding the chin straps with your thumbs. Then “roll” the helmet onto your head starting at the forehead. Continue rolling the helmet on towards the back of the head until it comes to rest with your head fully in contact with the inner lining and cheek pads.

### HOW TO USE CHINSTRAP

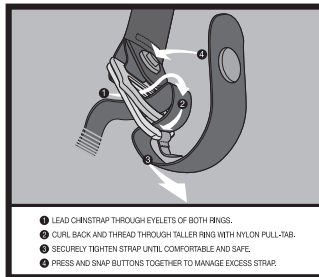

- 1 LEAD CHINSTRAP THROUGH EYELETS OF BOTH RINGS.
- 2 CURL BACK AND THREAD THROUGH TALLER RING WITH NYLON PULL-TAB.
- 3 SECURELY TIGHTEN STRAP UNTIL COMFORTABLE AND SAFE.
- 4 PRESS AND SNAP BUTTONS TOGETHER TO MANAGE EXCESS STRAP.

### FIRMLY AND SECURELY FASTEN YOUR CHINSTRAP.

Check your chinstrap for tightness occasionally as vibration or wind may loosen it.

### Cleaning Your Helmet System

None of the components of your ScorpionExo® helmet can be damaged by water. All headliners and sweat-wicking cheek pads are machine washable. Wash them with a mild detergent in warm water and allow to air dry. Hand washing is recommended, but machine washing is also permitted. Use the “delicate” cycle to prevent the agitator from damaging the

Continued on pg. 9 >>

Continued from pg. 9 >>

sweat-wicking material covering the liner parts. Do not place lining parts in the dryer: Excess heat may damage the foam and coverings. The faceshield may be cleaned with plastic polish or mild soap and water. The shell of your helmet should be cleaned using only a mild detergent and water. NEVER USE PETROLEUM BASED CHEMICALS, SOLVENTS, GASOLINE, CLEANING AGENTS OR ADHESIVES to clean the shell, liners or faceshield of your helmet. Your helmet shell, liner and faceshield may be seriously damaged by the use of such products.

### Warning



For your safety, it is important that you completely read the owner's manual and all warning labels.

### DO NOT



- DO NOT** ride without snugly fastening your chinstrap.
- DO NOT** clean your helmet with petroleum products, solvents, benzene, thinner or cleaning agents.
- DO NOT** paint over your helmet's finish without totally protecting and isolating the shock-absorbing liner and plastic parts. Your warranty will otherwise be invalidated.
- DO NOT** drop your helmet from any height onto a hard surface. This could cause damage to your helmet's finished and/or decrease its ability to protect you.
- DO NOT** place your helmet on your motorcycle's rearview mirror: The sharp pressure from the mirror's edge will compress and damage the helmet's shock-absorbing liner.
- DO NOT** place your helmet on the motorcycle's seat or fuel tank. It can easily roll off and hit the ground causing damage to the helmet. It is best to place your helmet on the ground so it cannot fall in any direction.

**DO NOT** ride with a scratched faceshield. This can impair your vision, especially at night.

**DO NOT** modify any part of your helmet, e.g., drilling the shell or cutting and pressing the shock absorbing liner. Installation of sound systems, speakers and microphones reduces your helmet's ability to protect you and is not recommended.

**DO NOT** use the helmet again if it has either been dropped or involved in an accident. Replace it even if the damage is not visible to the naked eye.

**DO NOT** wear a dark or tinted faceshield (including the retractable SpeedView™ Sunvisor) in dark or poor visibility riding conditions.

**DO NOT** place your headliners and cheek pads in the dryer after washing. Allow them to air dry.

**DO NOT** attempt to remove, change or replace your faceshield while riding your motorcycle or ATV.

**DO NOT** use paint which requires heat curing.

### Warranty



For on-line registration of your new ScorpionEXO helmet, please log onto [www.scorpionusa.com/support/product-registration.html](http://www.scorpionusa.com/support/product-registration.html) . Should you have a warranty claim, please call 888-672-6774 or email [warranty@scorpionusa.com](mailto:warranty@scorpionusa.com) during business hours (PST). Details of your ScorpionEXO warranty can be found online: [www.scorpionusa.com/support/warranty-and-returns.html](http://www.scorpionusa.com/support/warranty-and-returns.html)

**YEAR**  
**5**  
**WARRANTY**

## FOLLOW US ON OUR SOCIAL NETWORKS



Like us on Facebook for a chance to win Scorpion products:  
<https://www.facebook.com/ScorpionExoUSA>



Follow us on Twitter to be the first to know about new products :  
<https://twitter.com/ScorpionExo>



Subscribe to our YouTube page for fresh videos on our latest products:  
<http://www.youtube.com/user/ScorpionNation>



Download our FREE iPhone/iPad App. available on the App Store:  
<http://itunes.apple.com/us/app/scorpionexo/id429393136?mt=8>



Follow us on Instagram for a visual look into the Scorpion nest:  
Search user @Scorpionexo or #scorpionexo

Scan to visit our website:



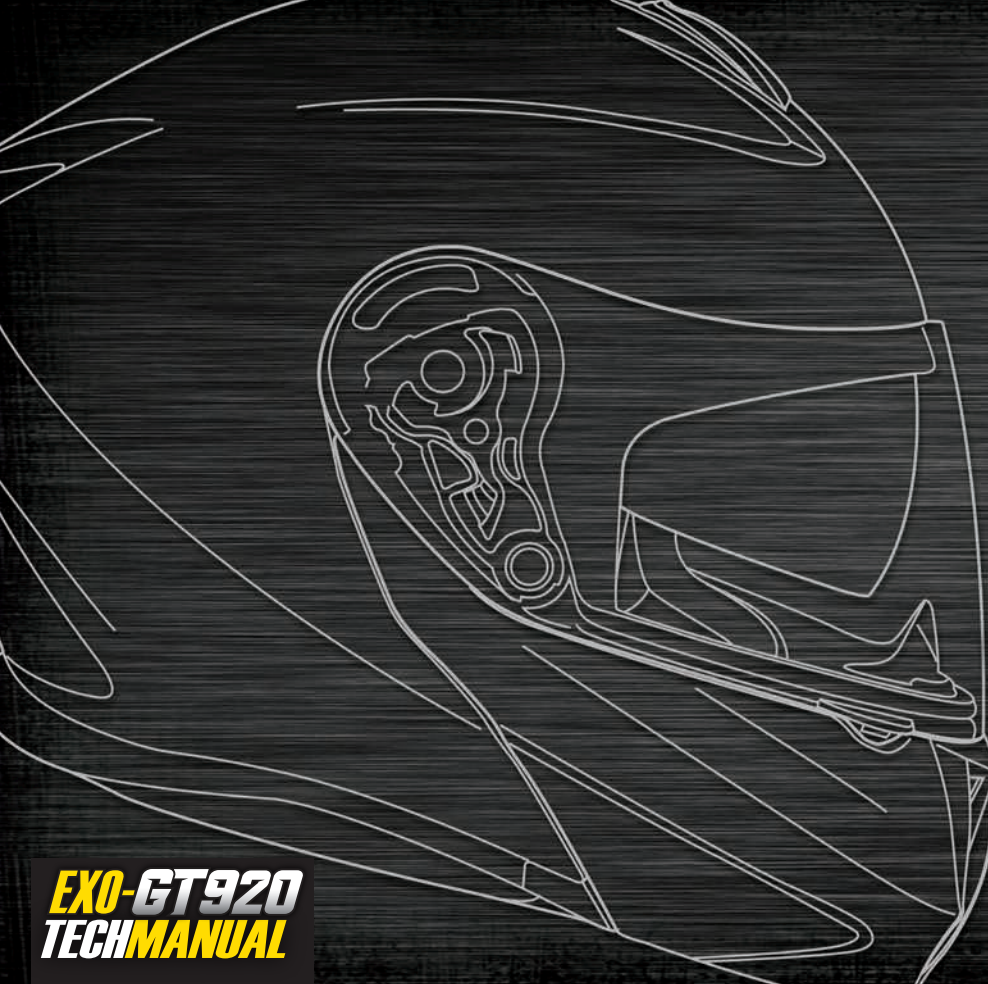

**EXO-GT920**  
**TECHMANUAL**



**ScorpionEXO Warranty/Tech Center**  
**10425 Slusher Drive**  
**Santa Fe Springs, CA 90670.USA**  
**T: 1.888.672.6774**  
**E: [warranty@scorpionusa.com](mailto:warranty@scorpionusa.com)**

Printed in China